



2016

MAKE TIME FOR PLAYTIME  
#LETSJAYCO



**2**  
YEAR  
WARRANTY



# #LETSJAYCO

When you travel with Jayco, fun is the only thing on the agenda. That's because we go the extra mile so you can live in the moment. From comfortable, amenity-packed floorplans to weather-shielding insulation and superior frame construction, you'll have everything you need to adventure every day and make yourself at home every night. Let's get away. Let's make it count. Let's Jayco—and make memories that last a lifetime.

## GENERATIONS OF FAMILY FUN



# WHITE HAWK

## BROADEN YOUR HORIZONS

Enjoy twice the expandable space—and the peace of mind—that comes with the industry's sturdiest slideouts. The White Hawk features impressive 36-inch-wide, ram-style slideouts with vacuum-bonded walls, double-bulb seals and a U-channel drip spout over all openings.



ARCHED INTERIOR RAFTERS AND 36-INCH, DEEP-WIDE SLIDES\*



SHARE YOUR PHOTOS AND STORIES ON SOCIAL MEDIA WITH [#LETSJAYCO](https://www.instagram.com/letsjayco)

\*Available on select models

  
**Jayco**<sup>®</sup>  
 Generations of family fun.



32DSBH interior



32DSBH kitchen closed



32DSBH kitchen open



32DSBH bedroom

# WHITE HAWK

## GET MORE, TOW LESS

You won't want for space—or fun—in the 2016 White Hawk. Double-wide slides\* pair with premium standards for a top-of-the-line lightweight package. Meanwhile, thoughtfully designed floorplans—including Murphy bed models—make this line an unbeatable value.

\* Available on select models



32DSBH bathroom



28RBKS awning with LED lights



32DSBH interior



32DSBH dinette closed



32DSBH dinette open



32DSBH rear bunk



32DSBH hide-a-bed



28RBKS exterior kitchen

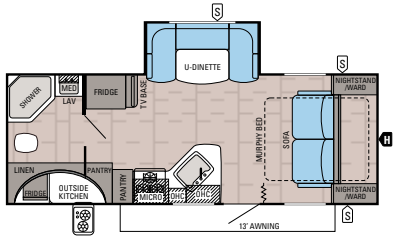

**WHITE HAWK | 23MRB**

Ext. Lgth: 25' 11" Ext. Ht: 129" Unloaded Wt (lbs.): 5,075 Sleeps: 2-4

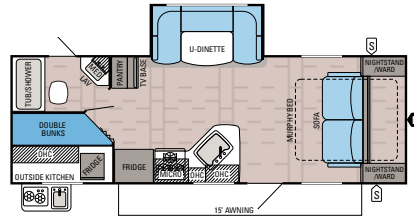

**WHITE HAWK | 24MBH**

Ext. Lgth: TBD Ext. Ht: TBD Unloaded Wt (lbs.): TBD Sleeps: 4-6

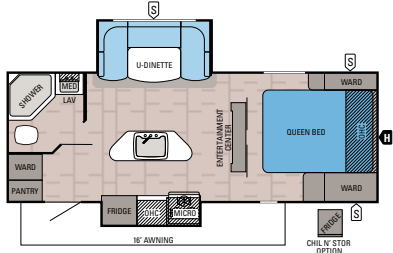

**WHITE HAWK | 24RDB**

Ext. Lgth: 26' 10" Ext. Ht: 132" Unloaded Wt (lbs.): 5,295 Sleeps: 3-4

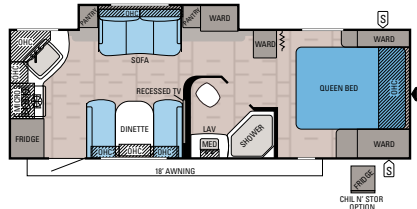

**WHITE HAWK | 24RKS**

Ext. Lgth: 28' 9" Ext. Ht: 131" Unloaded Wt (lbs.): 5,210 Sleeps: 4-6

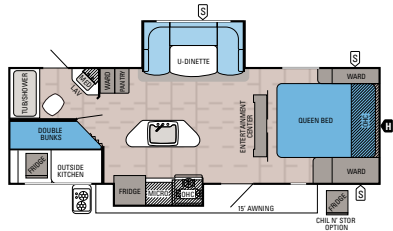

**WHITE HAWK | 25BHS**

Ext. Lgth: 29' 5" Ext. Ht: 131" Unloaded Wt (lbs.): 5,745 Sleeps: 7-8

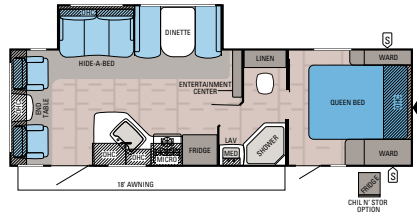

**WHITE HAWK | 27DSRL**

**OPTION: A**

Ext. Lgth: TBD Ext. Ht: TBD Unloaded Wt (lbs.): TBD Sleeps: 4-6

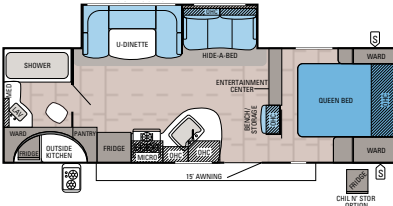

**WHITE HAWK | 27RBOK**

**OPTION: A**

Ext. Lgth: 31' 5" Ext. Ht: 131" Unloaded Wt (lbs.): 5,955 Sleeps: 4-6

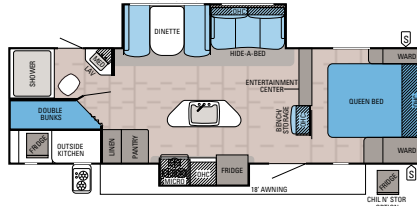

**WHITE HAWK | 28BHKS**

**OPTION: A**

Ext. Lgth: 32' 11" Ext. Ht: 134" Unloaded Wt (lbs.): 6,685 Sleeps: 8-9

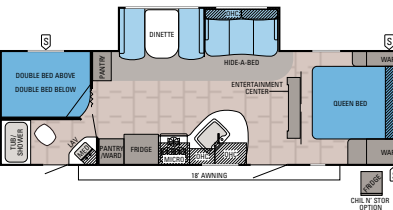

**WHITE HAWK | 28DSBH**

**OPTION: A**

Ext. Lgth: 32' 9" Ext. Ht: 134" Unloaded Wt (lbs.): 6,020 Sleeps: 7-10

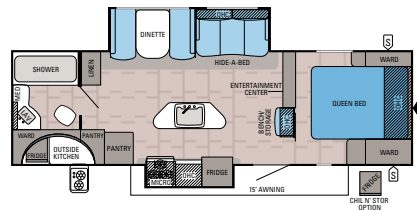

**WHITE HAWK | 28RBKS**

**OPTION: A**

Ext. Lgth: 31' 11" Ext. Ht: 131" Unloaded Wt (lbs.): 6,205 Sleeps: 4-6

**OPTIONS:**

**OPTION: A**



TABLE & CHAIRS OPTION

**OPTION: B**



ENTERTAINMENT CENTER W/ LEDGESTONE FIREPLACE OPTION

**OPTION: C**

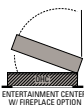

ENTERTAINMENT CENTER W/ FIREPLACE OPTION

**OPTION: D**



ENTERTAINMENT CENTER W/ FIREPLACE OPTION

**OPTION: E**



ENTERTAINMENT CENTER W/ FIREPLACE OPTION

**FLOORPLAN LEGEND:**

- STORAGE
- TRAILER HITCH
- LAV BATHROOM SINK
- MED MEDICINE CABINET
- MICRO MICROWAVE
- OHC OVERHEAD CABINETS
- FRIDGE REFRIGERATOR
- WARD WARDROBE



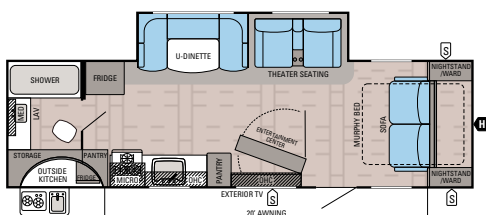

### WHITE HAWK | 29MEC OPTION: A, C

Ext. Lgth: **TBD** Ext. Ht: **TBD** Unloaded Wt (lbs.): **TBD** Sleeps: **3-4**

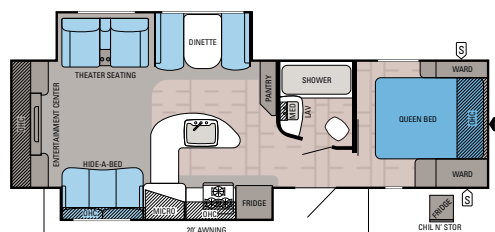

### WHITE HAWK | 29REKS OPTION: A, B

Ext. Lgth: **33' 9"** Ext. Ht: **135"** Unloaded Wt (lbs.): **7,025** Sleeps: **4-6**

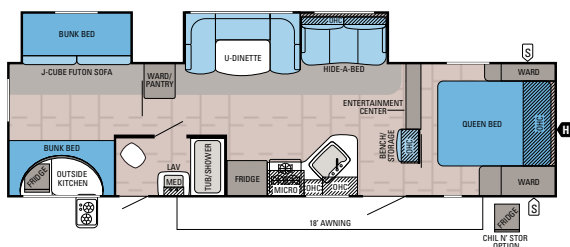

### WHITE HAWK | 32DSBH OPTION: A

Ext. Lgth: **TBD** Ext. Ht: **TBD** Unloaded Wt (lbs.): **TBD** Sleeps: **9-11**

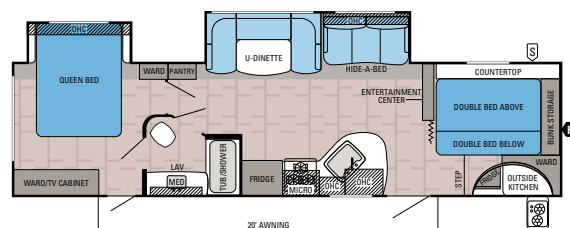

### WHITE HAWK | 33BHBS OPTION: A

Ext. Lgth: **TBD** Ext. Ht: **TBD** Unloaded Wt (lbs.): **TBD** Sleeps: **8-10**

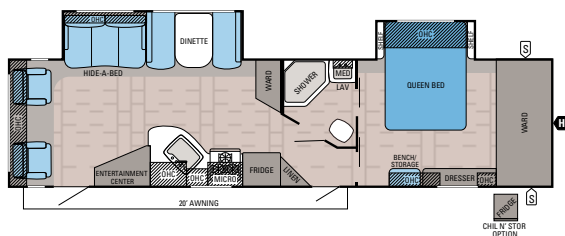

### WHITE HAWK | 33RLBS OPTION: A, D

Ext. Lgth: **TBD** Ext. Ht: **TBD** Unloaded Wt (lbs.): **TBD** Sleeps: **4-6**

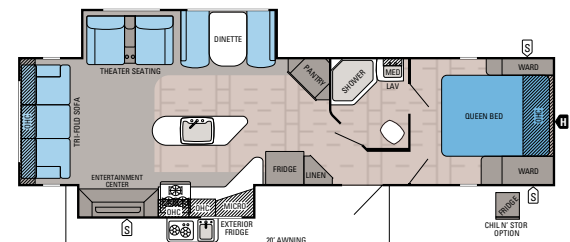

### WHITE HAWK | 33RSKS OPTION: A, E

Ext. Lgth: **TBD** Ext. Ht: **TBD** Unloaded Wt (lbs.): **TBD** Sleeps: **4-6**

## WHITE HAWK SPECIFICATIONS

MODELS	DIMENSIONS				WEIGHT (LBS.)				TANKS (GALS.)		
	FLOORPLAN	EXTERIOR TRAVEL LENGTH	EXTERIOR WIDTH	EXTERIOR HEIGHT WITH A/C	INTERIOR HEIGHT	UNLOADED VEHICLE WEIGHT	DRY HITCH WEIGHT	GROSS VEHICLE WEIGHT RATING	CARGO CARRYING CAPACITY	FRESH WATER CAPACITY (INCLUDES WATER HEATER)	GRAY WASTE WATER CAPACITY
23MRB	25' 11"	96"	129"	78"	5,075	630	6,500	1,425	48	30.5	30.5
24MBH	TBD	96"	TBD	81"	TBD	TBD	TBD	TBD	TBD	TBD	TBD
24RDB	26' 10"	96"	132"	81"	5,295	585	6,750	1,455	48	30.5	30.5
24RKS	28' 9"	96"	131"	81"	5,210	605	6,500	1,290	48	45	30.5
25BHS	29' 5"	96"	131"	81"	5,745	680	7,250	1,505	48	30.5	30.5
27DSRL	TBD	96"	TBD	81"	TBD	TBD	TBD	TBD	TBD	TBD	TBD
27RBOK	31' 5"	96"	131"	81"	5,955	715	7,750	1,795	48	45	30.5
28BHKS	32' 11"	96"	134"	81"	6,685	750	8,500	1,815	48	53	30.5
28DSBH	32' 9"	96"	134"	81"	6,020	655	7,500	1,480	48	45	30.5
28RBKS	31' 11"	96"	131"	81"	6,205	760	7,950	1,745	48	53	30.5
29MEC	TBD	96"	TBD	81"	TBD	TBD	TBD	TBD	TBD	TBD	TBD
29REKS	33' 9"	96"	135"	81"	7,025	755	8,500	1,475	48	61	30.5
32DSBH	TBD	96"	TBD	81"	TBD	TBD	TBD	TBD	TBD	TBD	TBD
33BHBS	TBD	96"	TBD	81"	TBD	TBD	TBD	TBD	TBD	TBD	TBD
33RLBS	TBD	96"	TBD	81"	TBD	TBD	TBD	TBD	TBD	TBD	TBD
33RSKS	TBD	96"	TBD	81"	TBD	TBD	TBD	TBD	TBD	TBD	TBD

\* The weights of certain options and/or option packages are not included in the UVWV listed in the specifications chart.

**Unloaded Vehicle Weight (UVW):** Sometimes referred to as "Dry Weight," UVW means the typical weight of this trailer as built at the factory. The UVW, as used in product literature and other promotional materials, does not include cargo, fresh water, propane, options or dealer-installed accessories.

**Gross Vehicle Weight Rating (GVWR):** GVWR means the maximum permissible weight of the trailer, including the UVW plus passengers, personal items, all cargo, fluids, options, and dealer-installed accessories. The GVWR is equal to or greater than the sum of the UVW and the CCC.

**Cargo Carrying Capacity (CCC):** CCC means the maximum weight of all passengers, personal items, food, fresh water, propane, tools, other cargo and dealer-installed accessories that can be carried by the trailer. CCC is equal to or less than GVWR minus UVW. The addition of options will decrease the CCC.

**Hitch Weight (HW):** The hitch weight, as used in product literature and other promotional materials, does not include cargo, fresh water, propane gas, options or dealer-installed accessories. The addition of these types of items will either add to or subtract from the stated hitch weight.

It is important for your safety and enjoyment that your tow vehicle be adequately sized and equipped to tow and handle the GVWR of the RV you select. Review weights and rating of your tow vehicle and consult a competent advisor for questions or advice. Whether you are new to RVing or a veteran, get a feel for the performance of your tow vehicle before heading out on the roadways. When you tow an RV, you must drive differently than when you drive a single vehicle. Practice hooking up, driving, backing up and braking in a safe environment or seek out professional instruction. Jayco affixes a weight label to each RV which lists weight information for that vehicle. See specifications chart above.

WE START WITH ONE OF THE INDUSTRY'S  
**strongest**  
**foundations**

Many competitors modify or weld stock frames, which can weaken the integrity of your foundation. Jayco's custom-manufactured frames offer higher strength and durability.

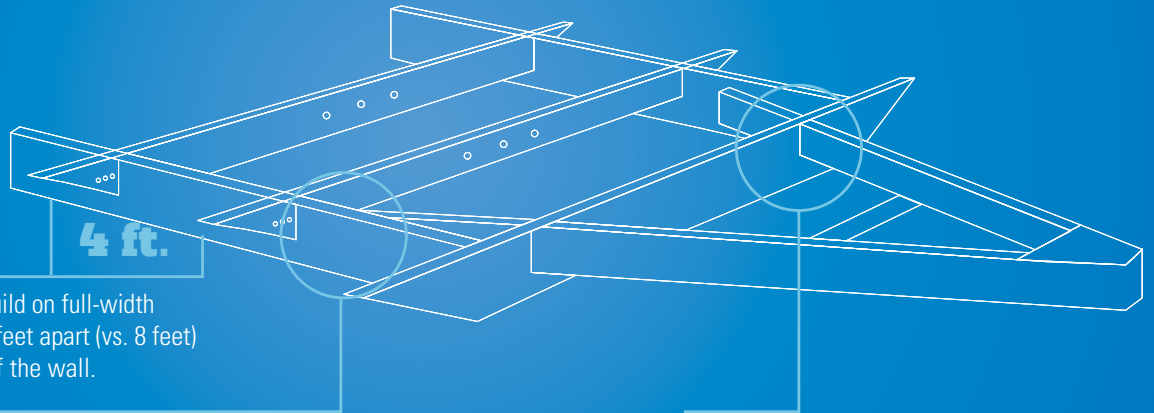

**Full-width outriggers:** We build on full-width outriggers that are spaced 4-6 feet apart (vs. 8 feet) to better support the weight of the wall.

**Norco® NextGen frame:** White Hawk features the industry's best strength-to-weight ratio thanks to a Norco NextGen frame made of high-strength, low-alloy sheet steel, Huck® bolts and an interlocking design.

**Integrated A-frame:** The A-frame runs through the main frame, preventing the hitch from buckling—a common issue in competing tack-welded designs.

Learn more at [StrongFoundation.Jayco.com](http://StrongFoundation.Jayco.com)

Is your tow vehicle  
**WHITE HAWK** ready?



Scan the QR code for complete towing guide resources.

## CUSTOMER VALUE PACKAGE

- 13,500-BTU A/C
- Spare tire and cover
- Microwave
- 6-gallon gas/electric auto-ignition water heater
- ABS propane bottle cover
- Bath skylight
- Outside shower
- Oven
- Tub surround
- Aluminum rims
- Power awning with LED light
- Power tongue jack

## STANDARD EXTERIOR EQUIPMENT

- Aerodynamic, rounded front profile with front diamond plate
- Deluxe graphics package
- TuffShell™ vacuum-bonded, laminated side, rear and front walls including slide walls
- Magnum Truss™ Roof System with one-piece seamless DiFlex II material
- 5/8-inch tongue-and-groove, plywood-decked flooring
- Fully enclosed underbelly
- Norco NextGen frame with integrated A-frame
- Frameless G20 dark-tinted windows
- 30-inch friction-hinged main entry doors
- Swing-out grab handle
- Exterior TV bracket with 110V and cable outlet
- Outdoor camp kitchen (23MRB, 24MBH, 25BHS, 27RBOK, 28RBKS, 28BHKS, 29MEC, 32DSBH, 33RSKS, 33BHBS)
- Slam-latch™ on front pass-through storage doors
- Marine-grade exterior speakers (2)
- Radial tires
- Tracker-Wide™ axles with E-Z Lube® axles
- Galvanized steel, impact-resistant wheel wells

- Slideouts with double seals, barrier sponges and U-channel drip spout
- Black tank flush system
- Utility lighting system—entrance step, baggage compartment, hitch and dump station
- 30-amp service
- Dual 20-pound propane bottles with auto regulator
- Solar prep
- Stabilizer jacks with sand pads (4)
- Detachable power cord

## STANDARD INTERIOR EQUIPMENT

- Solid hardwood mortise-and-tenon jointed cabinets
- Screwed lumbercore cabinet stiles
- Overhead cabinetry with etched-glass and bead board inserts
- Large residential countertops
- Deep single-bowl acrylic sink with high-rise faucet and sink cover
- 6-cubic-foot (28RBKS and 28BHKS only) or 8-cubic-foot Norcold® refrigerator with magnet-friendly front panels
- 3-burner, 9,000-BTU range
- Decorative backsplash
- Ball-bearing drawer glides with 75-pound capacity
- Arched interior ceiling
- Crown molding and wood batten strips on ceiling
- LED lighting throughout
- Directional and closeable central A/C vents
- 24-inch or 32-inch LED TV
- AM/FM/CD home-theater-style DVD player and Bluetooth®
- Tri-fold sofas (excluding 24RKS, 24RDB, 25BHS and Murphy bed models)
- Large MaxView tinted safety-glass window (60-inch on standard dinettes, 70-inch on U-shaped dinettes)
- Booth dinettes with removable storage totes underneath (most models)
- Plywood dinette, bunk and bed bases
- Wood grain accent paneling on select interior walls
- 60-inch x 80-inch queen beds with built-in storage totes (60-inch x 74-inch in Murphy bed models only)
- Jayco-exclusive pillow-top Denver Mattress® with bedspread

- Full-height hanging wardrobes with adjustable shelves
- Solid wood door enclosures for master bedroom (excluding Murphy bed models)
- Jayco-exclusive Denver Mattress bunk mats and fixed bunks with 110V outlet and corner shelf
- Bathroom medicine cabinets
- Porcelain foot-flush toilet
- DiamondFlor® vinyl flooring with cold-crack resistance
- High-output Atwood auto-ignition furnace with wall thermostat

## OPTIONS

- Customer Value Package with 15,000-BTU A/C
- Ledgestone fireplace with 40-inch LED TV (29REKS only)
- Entertainment center with fireplace (29MEC, 33RSKS, 33RLBS)
- Kitchen skylight with shade
- Solid-surface kitchen countertops
- Free-standing table with 4 chairs in place of booth dinette (N/A 23MRB, 24MBH, 24RKS, 24RDB, 25BHS)
- Second 13,500-BTU A/C in rear bedroom (29REKS, 32DSBH, 33BHBS, 33RSKS, 33RLBS)
- 50-amp service with second A/C prep (29REKS, 32DSBH, 33BHBS, 33RSKS, 33RLBS)
- 30-pound propane bottles
- Glacier Package—Astro-Foil™ insulation added to floor, slide floor and roof
- Power stabilizer jacks
- Front molded cap with LED headlights (N/A 23MRB, 24MBH, 29MEC)
- Chil N' Stor exterior refrigerator (N/A 23MRB, 24MBH, 29MEC)
- Exterior folding table (2 feet x 4 feet) in pass-through storage (N/A 23MRB, 24MBH, 29MEC)
- Outside bumper-mount grill
- Roof ladder
- Power remote control for slides, power awning, awning light and power stabilizer jacks

# INTERIOR DÉCOR

## COFFEE



## TWILIGHT

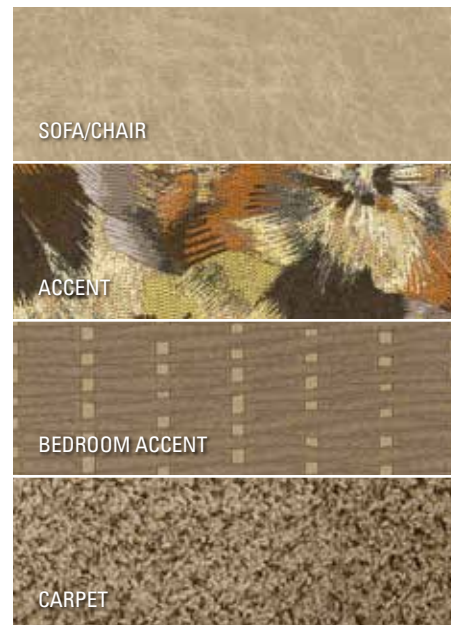

## SHADOW



# LET'S JAYCO—AND LEAVE OUR WORRIES BEHIND.



We know that your family fun rides on our commitment to quality. So we go the extra mile to make products that last—and stand behind them longer than anyone in the business.

## THE JAYCO DIFFERENCE

When you go with Jayco, you get one of the industry's strongest frames and rock-solid construction.

- 1. Walls are vacuum-bonded** for 15-18 minutes using 144 tons of pressure to ensure a strong bond
- 2. Seamless DiamondFlor vinyl**, laid over a  $\frac{5}{8}$ -inch tongue-and-groove plywood floor deck, stands up to family foot traffic and withstands cold, cracks and scratches
- 3. Lightweight materials and aerodynamic profile** for easier towing

**4. Extra-wide corner seals** on doors and windows to prevent leaks

**5. Magnum Truss™ Roof System** withstands 4,500 pounds—50 percent more than other roofs

**6.  $\frac{3}{8}$ -inch roof decking** secured at every seam

**7. One-piece, sidewall-wrapped DiFlex II** material provides the ultimate in leak protection



Generations of family fun.

## Meet your Jayco Dealer

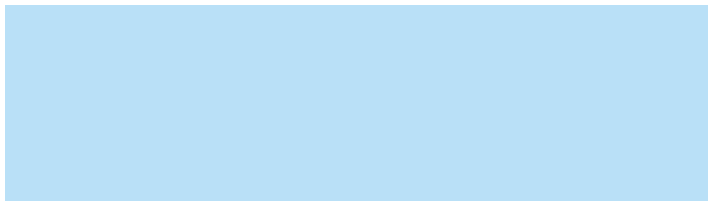

We work hard—so you can play hard. From finding the perfect Jayco for your family to providing flexible financing options and full-service support, we're here to help.

**2**  
YEAR  
WARRANTY

**FREE**

ROADSIDE  
ASSISTANCE

Travel with confidence, with our industry-leading, bumper-to-hitch limited warranty and a year's access to Coach-Net™—the country's largest RV emergency road service.

For a copy of our 2-year limited warranty with full terms and conditions, please contact your local Jayco dealer.

**eco** advantage™

**Jayco's long-term commitment to generations of family fun**

**After four years of increased efforts to eliminate waste, conserve energy and increase recycling, we've come a long way in building RVs that are not only better for your family—but also better for the planet.**

**Learn more at [Jayco.com/EcoAdvantage](http://Jayco.com/EcoAdvantage)**

## Follow Jayco



Jayco, Inc., P.O. Box 460, Middlebury, IN 46540, [www.jayco.com](http://www.jayco.com) ©RVIA See dealer for further information and prices. All information in this brochure is the latest available at the time of publication approval. Jayco reserves the right to make changes and to discontinue models without notice or obligation. Photos in this brochure may show optional equipment and props for photography purposes. RVs built for sale in Canada may differ to conform to Canadian codes. ©2015 Jayco, Inc. 0615-75K Printed in U.S.A.